



HDMI Switcher Series

User Manual

Model : HKM41E

4 x 1 HDMI KVM Multiviewer & Seamless Switcher



Introduction

HKM41E is a 4 input HDMI automatic KVM switcher that supports resolution up to 1080p@60Hz 4:4:4. This switcher is designed to control four HDMI sources (PC/NVR/DVR) from an HDMI display, a keyboard and a mouse. It also supports Multiview function which can reproduce all four images in one screen.

Features

- Resolution up to 1080p@60Hz 4:4:4.
- Supports Multiview function, providing different working modes.
- Controlled by panel buttons, keyboard/mouse, IR remote.
- Support mouse roaming, using one display and one keyboard/mouse to control four PC. Just move the mouse across the multi-viewer border, and the mouse immediately switches to the source and take control of the device.

Installation view

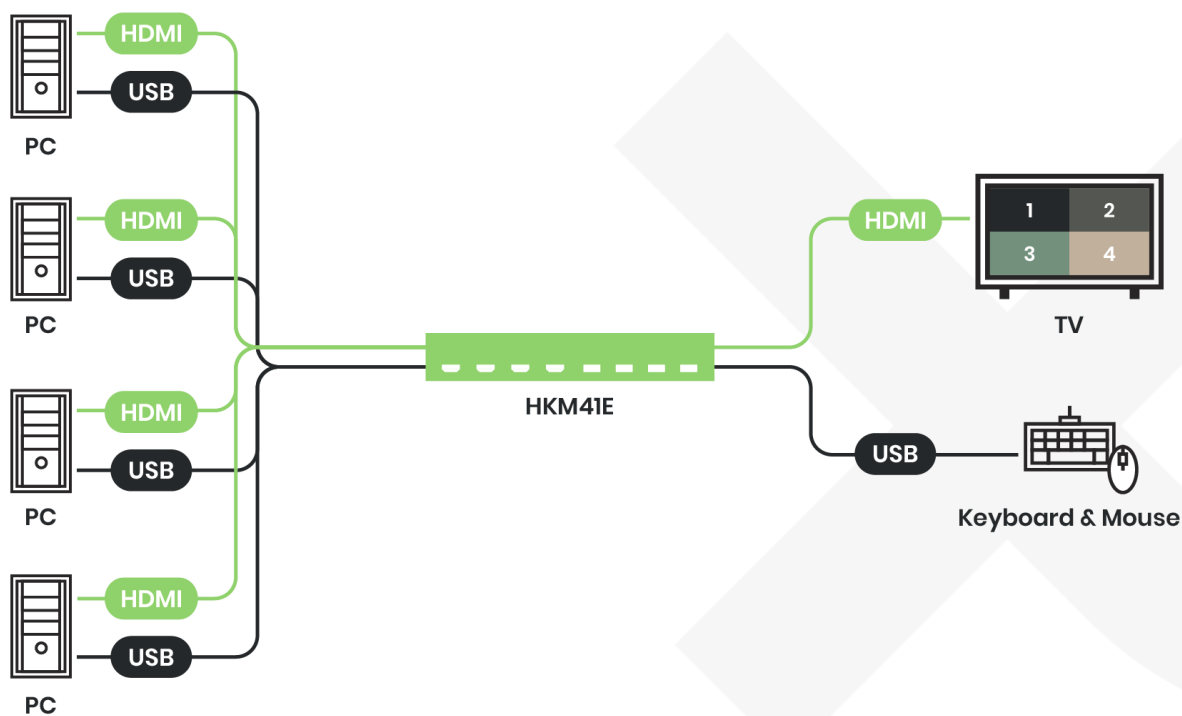

Panel view

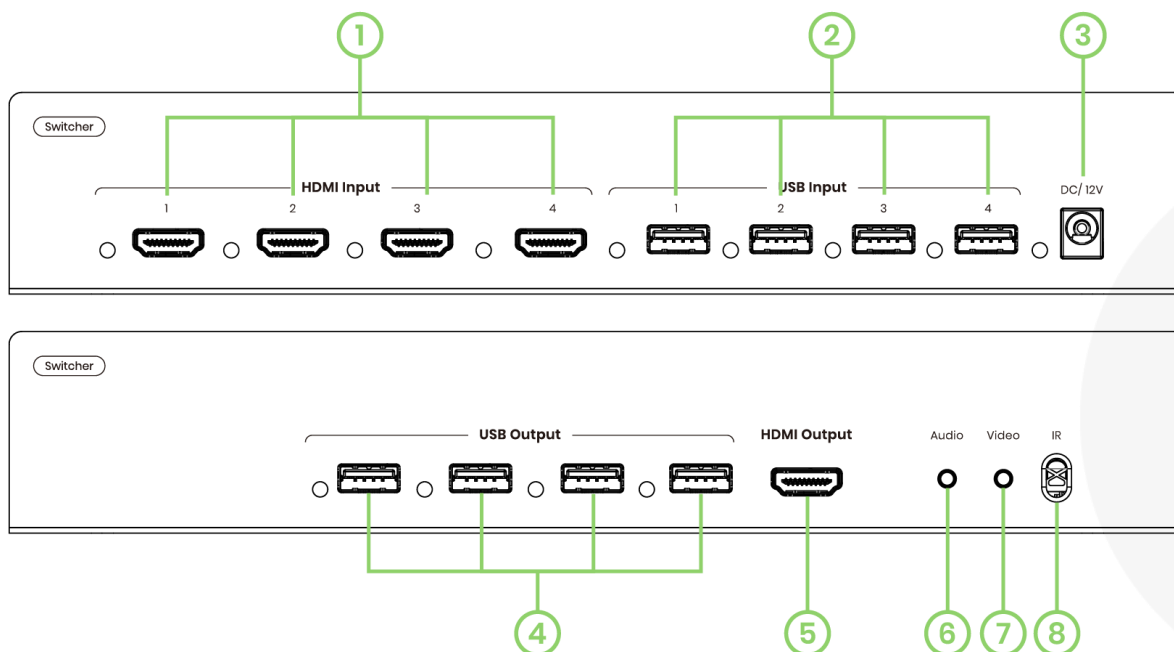

No	Interface	Description
1	HDMI Input	To input up to 4 HDMI sources
2	USB Input	To connect up to 4 USB sources
3	DC/12V	To input a DC 12V power
4	USB Output	To connect a keyboard & a mouse
5	HDMI Output	To connect an HDMI display
6	Audio	To mute/unmute audio or select an audio source (see page 6)
7	Video	To select a video mode
8	IR	To receive an IR control signal

LED Indication

Interface	LED Status	Description
Power	Green On	Power on
	Green Off	Power off
HDMI Input 1~4	Blue On	HDMI source detected
	Blue Off	No HDMI source
USB Input 1~4	Blue On	Corresponding PC host has been selected for KVM control (single-view)
		When set to control 4 PCs at the same time (4 LEDs on at the same time)
		When mouse position is in the corresponding PC host screen while in mouse roaming mode/multi-view (the USB LED would only be on one at a time, depending on which source the mouse currently on)
	Blue Off	No PC host has been selected for KVM control (single-view) Mouse position is not in the corresponding PC host screen while in mouse roaming mode (multi-view)
USB Output 1~4	Blue On	USB device detected (mouse/keyboard)
	Blue Off	USB device not connected

Video Modes



Mode 1



Mode 2



Mode 3



Mode 4

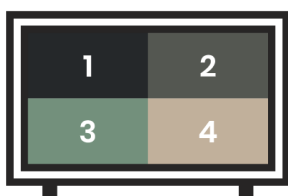

Mode 5

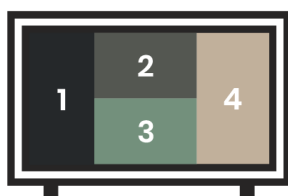

Mode 6

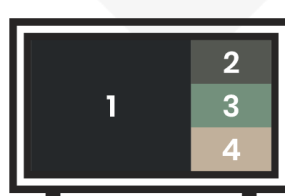

Mode 7



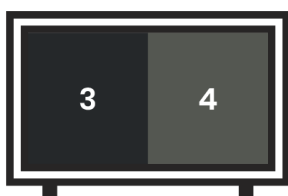

Mode 8





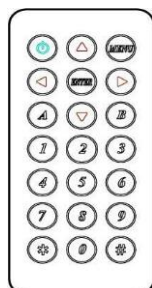













Mode 9

IR Controller



If you use the IR remote for the first time or just replace the battery, please set up the IR remote ID as 0 by pressing  and , which will match the remote ID with that of HKM41E.

Button	Function
	To the previous video (single-view) Sequence: Input 4 → 3 → 2 → 1 → 4 → ...
	To the previous video (single-view) Sequence: Input 4 → 3 → 2 → 1 → 4 → ...
	To the next video (single-view) Sequence: Input 1 → 2 → 3 → 4 → 1 → ...
	To the next video (single-view) Sequence: Input 1 → 2 → 3 → 4 → 1 → ...
	Select input 1 as the video source (Mode 1)
	Select input 2 as the video source (Mode 2)
	Select input 3 as the video source (Mode 3)
	Select input 4 as the video source (Mode 4)
	Quad-view (Mode 5)
	Quad-view (Mode 6)
	Quad-view (Mode 7)
	Dual-view (Mode 8)
	Dual-view (Mode 9)
	Select output resolution as 720p@60Hz/ 1080p@60Hz
	Mute/ unmute audio (see page 6)
	Auto-switching from Mode 1 ~ 9

Keyboard Hot Key Switching

Hot Key Combination	Function
'*' + 'F1'	Control PC 1
'*' + 'F2'	Control PC 2
'*' + 'F3'	Control PC 3
'*' + 'F4'	Control PC 4
'*' + 'F5'	Control 4 PCs (mouse/keyboard) at the same time
'*' + 'F6'	Mouse Roaming (only in Absolute Mouse Positioning Mode)
'*' + 'F9'	Absolute Mouse Positioning Mode (can only be used while controlling PCs)
'*' + 'F10'	Relative Mouse Position Mode (can only be used while controlling DVR/NVR)
'*' + '1'	Select input 1 as the video source (Mode 1)
'*' + '2'	Select input 2 as the video source (Mode 2)
'*' + '3'	Select input 3 as the video source (Mode 3)
'*' + '4'	Select input 4 as the video source (Mode 4)
'*' + '5'	Quad-view (Mode 5)
'*' + '6'	Quad-view (Mode 6)
'*' + '7'	Quad-view (Mode 7)
'*' + '8'	Dual-view (Mode 8)
'*' + '9'	Dual-view (Mode 9)
'*' + 'Page Up'	To the next video (single-view) Sequence: Input 1 → 2 → 3 → 4 → 1 → ...
'*' + 'Page Down'	To the previous video (single-view) Sequence: Input 4 → 3 → 2 → 1 → 4 → ...
'*' + 'F7'	Mute/ unmute audio (see page 6)
'*' + 'F8'	Select output resolution as 720p@60Hz/ 1080p@60Hz

Mute/ unmute Audio

By pressing  IR button, pressing the audio button on the front panel or '*'+F7' Hot Key, you can mute/ unmute/switch audio under video mode 1 ~ 9 as below.

Mode	"A" IR button/ front panel audio button/ '*'+F7' Hot Key Function
Mode 1	Mute/ unmute Input 1 audio
Mode 2	Mute/ unmute Input 2 audio
Mode 3	Mute/ unmute Input 3 audio
Mode 4	Mute/ unmute Input 4 audio
Mode 5	Select Input 1/ 2/ 3/ 4/ mute
Mode 6	Select Input 1/ 2/ 3/ 4/ mute
Mode 7	Select Input 1/ 2/ 3/ 4/ mute
Mode 8	Select Input 1/ 2/ mute
Mode 9	Select Input 3/ 4/ mute

Caution

- This product is designed for indoor applications. If it is desired for outdoor use, please install additional equipment for waterproof protection and surge protectors to prevent damages caused by lightning.
- Do not put anything on the power and system cables; place them where they cannot be stepped on. Please be sure there is nothing resting on any cables.
- Avoid using this product close to water places, or near high temperature devices such as radiators, stoves, etc.
- Shut down the power supply and unplugged all equipment immediately if:
 - water or any kind of liquid has been spilled into the product;
 - the product has been damaged by external force;
 - the product does not operate normally as this manual indicates;
 - Please contact us for further repair if above conditions happen.
- Using certified Premium HDMI cable to transfer high-resolution video is recommended.
- Seamless switching is supported only when switching between Mode 1 ~ 4.
- There is no constraint border when using mouse roaming function.
- When input video resolution is 800 x 600, output picture will be with black border on the left and right side of the screen.
- The sequence of the HDMI input should be matched along with the USB input (HDMI 1 corresponding with HDMI 1 source, etc.)
- While setting up HKM41E, please use the keyboard to get full access of all functions.
- When using DVR/NVRs as sources, must switch to Relative Mouse Position Mode, in this mode HKM41E doesn't support mouse roaming.
- When using PCs as sources, must switch to Absolute Mouse Position Mode in this mode HKM41E supports mouse roaming.
- The mouse roaming could not work under Relative Mouse Position Mode, so using DVR/NVR as sources could not active mouse roaming, but it can still be controlled by using keyboard hot keys.
- If HKM41E uses both PCs and NVR/DVRs as sources, the connected mouse/keyboard won't operate normally due to the restrictions of Absolute/Relative Mouse Position Modes.

What's in the Package

No	Item	Qty
1	HKM41E	x1
2	IR01 (IR Remote)	x1
3	12V 2A Power Adapter	x1
4	Accessory	x1

Specification

ITEM NO.	HKM41E
Support	
Input Video Resolution	1080p@60Hz
Output Video Resolution	1080p@60Hz
Audio Format	PCM2.0
Multi-view working modes	Normal View: display 1 input Dual View: display 2 inputs Quad View: display 4 inputs
Control Interface	Panel Buttons IR Remote Keyboard/Mouse (with Hot Key)
Seamless switching	Yes
Boundless switching	Yes
Ports & Interfaces	
Video Input	4 x HDMI Type A
Video Output	1 x HDMI Type A
USB Input	4 x USB Type A
USB Output	4 x USB Type A
Power	
Power Supply	12V 2A
Power Consumption	5W
Ambient Temperature	
Operation	0 to 55°C
Storage	-40 to 85°C
Humidity	Up to 95%
Physical Characteristics	
Dimensions	257 x 153 x 44 mm
Weight	1265.2g

Installation Guide

Stand-alone

Use rubber pads on the bottom of the products, preventing it from slippery.

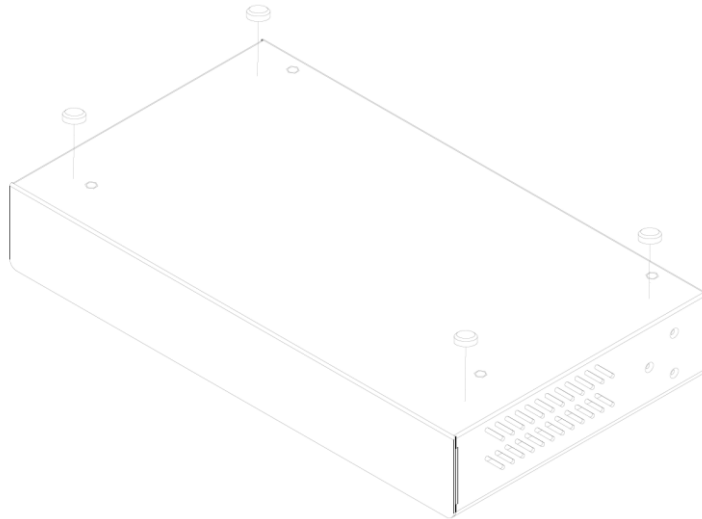

Use in a Cabinet

Fix angle irons on both sides of the products

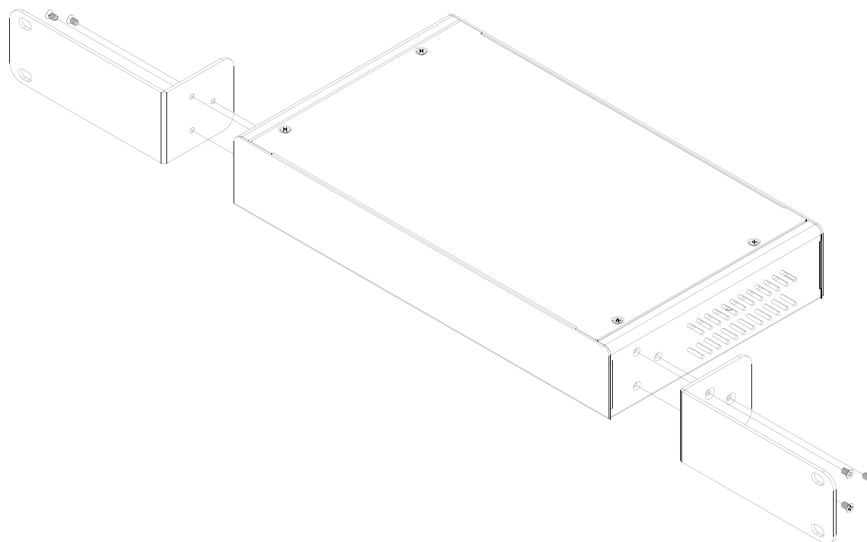

Fix in a cabinet

